

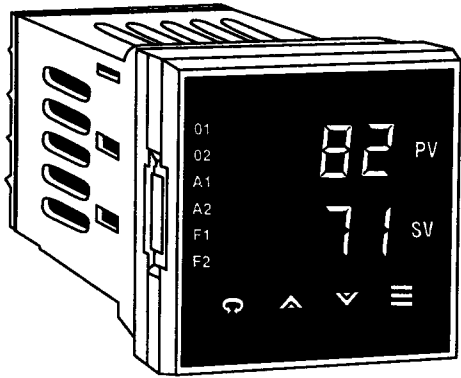

# User's Guide



<http://www.omega.com>  
e-mail: [info@omega.com](mailto:info@omega.com)

CN8500 Series  
1/16 DIN Temperature and  
Process Controllers

**Servicing North America:**

**USA:** ISO 9001 Certified  
One Omega Drive, Box 4047  
Stamford, CT 06907-0047  
Tel: (203) 359-1660  
FAX: (203) 359-7700  
e-mail: info@omega.com

**Canada:**  
976 Bergar  
Laval (Quebec) H7L5A1  
Tel: (514) 856-6928  
FAX: (514) 856-6886  
e-mail: canada@omega.com

**For immediate technical or application assistance:**

**USA and Canada:**  
Sales Service: 1-800-826-6342/1-800-TC-OMEGA<sup>SM</sup>  
Customer Service: 1-800-622-2378/1-800-622-BEST<sup>SM</sup>  
Engineering Service: 1-800-872-9436/1-800-USA-WHEN<sup>SM</sup>  
TELEX: 996404 EASYLINK: 62968934 CABLE: OMEGA

**Mexico and Latin America:**  
Tel: (95) 800-TC-OMEGA<sup>SM</sup>  
FAX: (95) 203-359-7807  
En Español: (203) 359-7803  
e-mail: espanol@omega.com

**Servicing Europe:**

**Benelux:**  
Postbus 8034, 1180 LAAmstelveen,  
The Netherlands  
Tel: (31) 20 6418405 FAX: (31) 20 6434643  
Toll Free in Benelux: 06 0993344  
e-mail: nl@omega.com

**Czech Republic:**  
ul. Rude armady 1868, 733 01 Karvina-Hranice,  
Czech Republic  
Tel: 420 (69) 6311627 FAX: 420 (69) 6311114  
e-mail: czech@omega.com

**France:**  
9, rue Denis Papin, 78190 Trappes  
Tel: (33) 130-621-400 FAX: (33) 130-699-120  
Toll Free in France: 0800-4-06342  
e-mail: france@omega.com

**Germany/Austria:**  
Daimlerstrasse 26, D-75392  
Deckenpfronn, Germany  
Tel: 49 (07056) 3017 FAX: 49 (07056) 8540  
Toll Free in Germany: 0130 11 21 66  
e-mail: germany@omega.com

**United Kingdom:** ISO 9002 Certified  
• 25 Swannington Road, Broughton Astley,  
Leicestershire, LE9 6TU, England  
Tel: 44 (1455) 285520 FAX: 44 (1455) 283912  
• P.O. Box 7, Omega Drive, Irlam,  
Manchester, M44 5EX, England  
Tel: 44 (161) 777-6611 FAX: 44 (161) 777-6622  
Toll Free in England: 0800-488-488  
e-mail: uk@omega.com

It is the policy of OMEGA to comply with all worldwide safety and EMC/EMI regulations that apply. OMEGA is constantly pursuing certification of its products to the European New Approach Directives. OMEGA will add the CE mark to every appropriate device upon certification.

The information contained in this document is believed to be correct but OMEGA Engineering, Inc. accepts no liability for any errors it contains, and reserves the right to alter specifications without notice.

**WARNING:** These products are not designed for use in, and should not be used for, patient connected applications.

**Table of Contents**

<b>Installation</b>	
Mounting	8
Contact Identification	9
Sensor Input Connections	10
Power Wiring	11
<b>Operation</b>	
Notes on Outputs	12
Notes on Alarms	20
Parameter Menu Organization and Descriptions	23
Tuning Procedures	28
<b>Options</b>	
Auto/Manual	34
Remote Setpoint Select	34
Recorder Output (PV retransmission)	36
Transducer Excitation	37

## **Table of Contents**

<i>Digital Communications</i>	38
<i>Recalibration Procedure</i>	46
<i>Error Codes</i>	47
<i>Warranty/Repair Information</i>	52
<i>Technical Specifications</i>	48
<i>Ordering Codes</i>	52

## **Features**

### ***The OMEGA® CN8500 Temperature and Process Controller features:***

- ✓ Omega Logic™ (allows selection of various cooling and damping settings relative to single and multi-lag processes and storage effects)
- ✓ Single input, RTD, thermocouple, current and voltage input models available
- ✓ Voltage and current models scalable from -1999 to 9999
- ✓ Non-volatile memory
- ✓ NEMA 4X front panel
- ✓ Adjustable hysteresis and heat-cool spread
- ✓ User-selectable control modes (PID, PI, PD, and On/Off)
- ✓ User-selectable ramp to setpoint
- ✓ Auto-tuning, heat or cool
- ✓ Dual output and alarm capability
- ✓ RS-232 and RS-485 communications
- ✓ Twin-branched double wipe contacts
- ✓ Rugged molded housing with barriers and locking terminals
- ✓ 100 mm depth behind panel
- ✓ Wide range power supply: 100 to 250 Vac and 100 to 330 Vdc; 24 Vac/Vdc optional

## Installation

Measurements between centerlines of panel cutouts are minimum recommended.

**Figure 1. Recommended Panel Layout for Multiple Controllers**

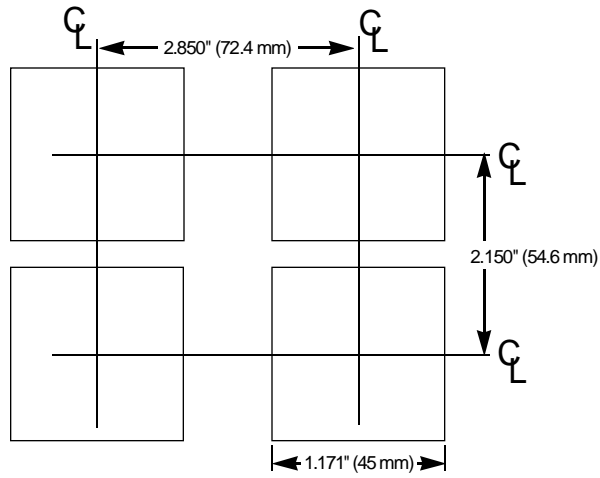

## Installation

**Figure 2. Case Dimensions**

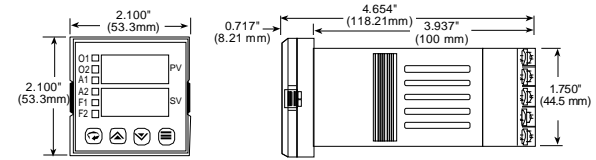

Prior to mounting the CN8500 Series in your panel, make sure that the cutout opening is of the right size, 1.771" x 1.771" (45 mm x 45 mm), and deburred to enable a smooth fit. A minimum of 4" (100 mm) of depth behind the panel is required.

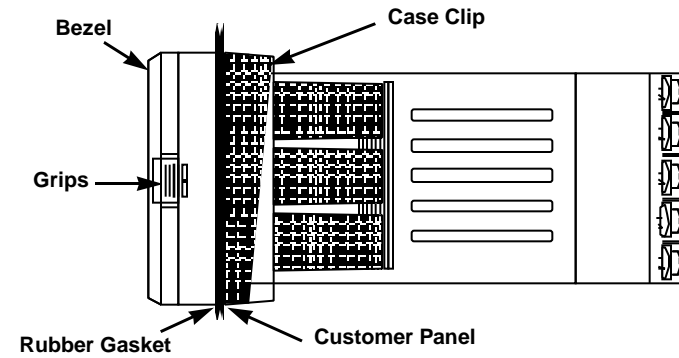

**Figure 3. CN8500 Series Mechanical Components**

## Mounting

Slide the mounting collar off and remove any wrapping material from the instrument. (To ease removal of the collar, gently pry up all three tabs on each side with a thin-blade screwdriver.)

Insert the CN8500 Series through the front panel cutout and slide the mounting collar back onto the unit from behind the panel. Press the tabs of the mounting collar into the ridges of the case housing. The case should now be secure in the cutout.

If it can still be moved, reposition the mounting collar until the unit is completely immobile within the panel.

If it is necessary to remove the CN8500 Series chassis from the case housing, press the grips on each side of the front panel bezel firmly until the tabs release. The chassis may then be pulled out. To re-install, press both bezel grips simultaneously and carefully push the chassis back into the case housing until the tabs snap into place.

## Notes on Wiring

**IMPORTANT:** All electrical wiring connections should be made only by trained personnel, and in strict accordance with the National Electrical Code and local regulations.

Power and signal wires should always be kept separate and input leads should never be placed in the same conduit as power leads. We recommend separating connecting wires into bundles: power, signal, alarms and outputs. These

bundles should then be routed through individual conduits. Shielded sensor cables should always be terminated at panel ground.

If additional RFI attenuation is required, noise suppression devices such as an R.C. snubber at the external noise source may be used.

**Figure 4. Contact Identification**

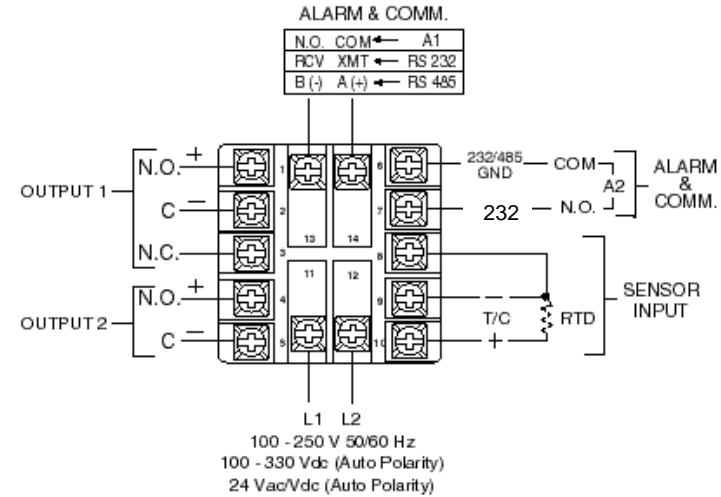

## Sensor Input Connections

Thermocouple circuit resistance should not exceed 100 ohms for rated accuracy; errors will occur at higher resistance values. If shielded thermocouple wire is used, terminate the shield only at panel ground.

**Figure 5. Thermocouple Input Wiring**

Make sure that you are using the appropriate thermocouple and extension wire. Connect the negative lead (generally colored red in ISA-type thermocouples) to contact #9; connect the positive lead to contact #10. Extension wires must be the same polarity as the thermocouple.

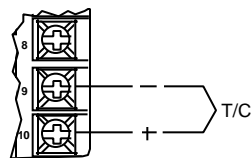

**Figure 6. RTD Wiring**

The CN8500 Series accepts input from 2- or 3-wire, 100 ohm platinum resistance temperature detectors (RTDs). Connect 2-wire RTDs to contacts #9 and #10, with a jumper across contacts #8 and #9. Keep leads short and use heavy gauge copper extension wire, if necessary, to minimize lead resistance. For long runs, 3-wire RTDs should be used.

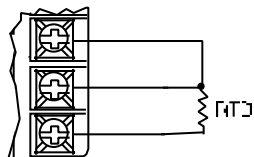

Note: For 2 Wire RTD  
Jumper 8 & 9

**Figure 7. Process and Linear Input Wiring**

Voltage Inputs: Connect the positive voltage input to contact #10; the negative input to contact #8. mV/Current Inputs: Connect the positive current input to contact #10; the negative input to #9.

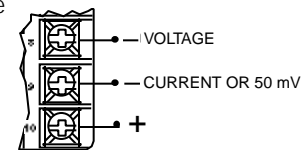

## Power Wiring

The CN8500 Series power supply accepts 100 to 250 Vac, 100 to 330 Vdc, or 24 Vac/Vdc line power without any switch settings or polarity considerations. All connections should be made in accordance with the National Electrical Code and local regulations, using only NEC Class 1 wiring for all power terminals.

It is advisable, but not necessary, to fuse one leg of the incoming power line, contact #11, with a 2AG, 0.5 amp rated fuse. Be sure that only instrument power input is fused — not power to the load.

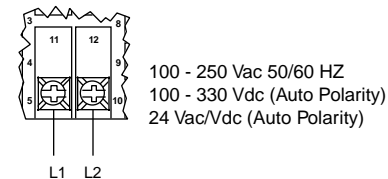

**Figure 8. Power Wiring Connection**

### ***Omega CN8500 Series Universal Controller***

The CN8500 Series is a full-function, autotuning PID controller, calibrated and pre-configured for your application requirements, according to the ordering code specified, either as a temperature or linear process controller.

Just a few easy steps are required before the instrument can be placed into service. After completing the mounting and wiring procedures as previously instructed, set your individual process parameter values by stepping through the CN8500 Series' setup menus, using the simple front-panel keys as instructed. Then, initiate the autotuning sequence as shown (or tune manually).

#### ***Notes on Outputs***

When you ordered your CN8500 Series controller, a specific output type was specified, designated as either "R1,R2", "F1, F2", "DC1,DC2", or "T1,T2". If you ordered the dual-output CN8502 model, you also had the option of configuring your controller with either one or two output actions. Generally, output 1 is a heat (reverse-acting) function and output 2 is a cool (direct-acting) function. For best results, follow the recommendations for setting cycle times for the output type supplied with your controller. A brief description of output types follows:

Output Type	Description
R	5A/3A (120/240 Vac) relay, normally open, used for switching resistive loads. If relays or solenoids are to be driven, select the "T" output.
F	4-20 mA, full output to load with 500 ohm impedance max. (suppressed).
DC	20 Vdc pulsed output for solid-state relays.
T	1 A @ 120/240 Vac , solid-state relay, zero voltage-switched and optically isolated from drive signal. Only resistive loads to may be controlled directly. Larger loads may be controlled using an external contactor.

## Operation

Figure 9. Front Panel Controls and Indicators

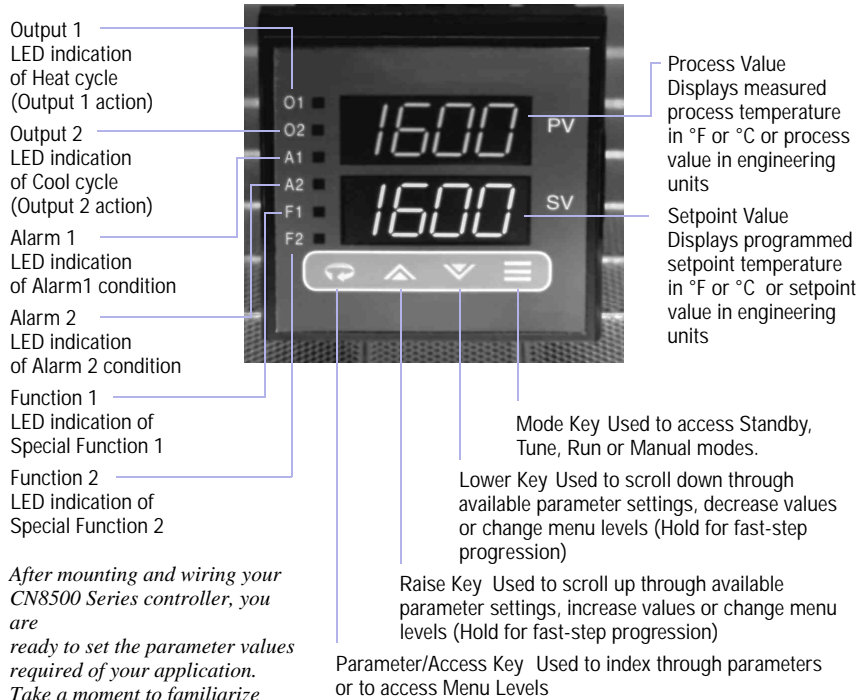



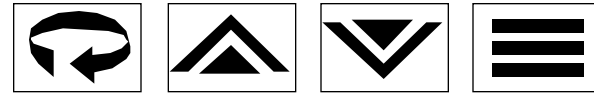

After mounting and wiring your CN8500 Series controller, you are ready to set the parameter values required of your application. Take a moment to familiarize yourself with the unit's front panel controls and indicators.

## Operation

### Power On



When power is first applied to the CN8500 controller, all LED segments and indicators are momentarily illuminated. The Process Value (PV) window then displays [ -At- ] or [ -Ap- ] and the Setpoint Value (SV) window displays an initialization code, e.g., [ tf06 ]. The last two digits of this code indicate the software revision supplied with your controller. Please provide this revision number when contacting us regarding your controller. Depending upon whether Setpoint Target Time [ SP.tt ] is enabled, you may also see this symbol:  or . This means that the controller is ramping up or down to setpoint according to its previously programmed parameters. The default setpoint on initial power up is equal to the process value. Before proceeding further, wait until the display has stabilized and then use the Raise  or Lower  keys to enter or adjust your desired Setpoint Value.

### Parameter Menu Organization

Your CN8500 Series controller has five distinct menu levels. This enables quick access to relevant parameters without the need for scrolling through long menus. Menu "05" is used for



## Operation



*You cannot enter Standby Mode from menu level "00".*

*Follow the instructions for changing menu levels to select another level.*

initial controller configuration and menus "02" and "03" are used for setting or changing parameters. Menus "00" and "01" are used when the controller is in regular unattended operation and are not used for setting parameters. For safety and security purposes, we recommend placing the controller in menu level "00" or "01" when in regular operation; however, it is not required.

If you wish to "escape" from parameter selection within these menus at any time, simply press the Mode  key once. A description of the menu hierarchy and a detailed listing of menus and parameters begins on page 22.



### Standby Mode

When the controller is placed in Standby Mode, outputs are disabled; however, access is permitted to all menu levels and, unless the controller is at Run menu levels "00" or "01", operating parameters may still be changed. Use this mode for tuning the controller. To enter Standby Mode, press and hold the Mode key  for four seconds until the lower window display flashes [ StbY ]. To exit Standby Mode from Menu Levels "01" to "05", press and hold the Mode  key for four seconds until the lower window display flashes [ tUnE ]. (If the Damping setting in menu "02" is [ OFF ], then [ HEAT ] or [ Cool ] will be displayed instead of [ tUnE ]. Press and hold the Mode key for four more seconds until the lower window returns to a steady display of Setpoint Value.





## Operation

(This procedure will not affect tuning). Removing power to the controller will also take the instrument out of Standby Mode.

### Accessing Menu Levels

To access menu levels from Standby Mode from menu levels "02" to "05", press the Parameter/Access  key once. From menu levels "00" and "01", press and hold the Parameter/Access  key for approximately 11 seconds until the lower window display alternates between [ Ac.Cd ] and the menu level number last activated.

### Changing or Displaying Menu Levels

To change menu levels, access the menu level display as instructed in the previous paragraph, then use the Raise  or Lower  key to set the desired menu level number. To display the current menu level setting in menu levels "02" to "05", from Standby or while adjusting/viewing parameters, press the Parameter/Access  key once. For menu levels "00" and "01", press and hold the Parameter/Access  key for approximately 11 seconds.





## Operation

*Because the CN8500 controller's initial configuration affects other menu levels, it is important to set all required parameters in this menu first before accessing other menu levels.*

### Menu Level Descriptions

#### Menu "05" (Configuration Setup)

This is the menu level used for specifying initial configuration parameters before the controller is placed in Run mode.

After changing the access code to "05" as instructed in the previous paragraph, press the Parameter/Access  key to step through the various control parameters. Available parameters will flash in the lower window display, alternating with the current value for that parameter. To increase or decrease the value, simply press the appropriate Raise  or Lower  key, then press the  key to step to the next parameter. To exit the menu at any time, press the Mode  key.

*Note: When programming in menu level "05", all outputs are disabled; however, any active alarms will remain active until the alarm condition is removed. New alarm conditions will not be recognized.*

#### Menu "04" (Communications and Calibration Setup)

This menu is used to set up the controller for digital communications and for recalibrating the controller. If your CN8500 Series controller was ordered with the digital communications option, set these parameters next. To access this menu level, follow the instructions previously given.

## Operation



#### Menu "03" (Alarm, Timing and Limit Setup)

In this menu, alarms, cycle times, setpoint target time and limits are established. After changing the access code to "03", press the Parameter/Access  key to step through the various parameters. To set or change parameter values, follow the instructions given previously.

#### Menu "02" (Control)

Gain, Rate and Reset parameters are automatically set during autotuning. However, they can be manually adjusted by the operator. To return the controller to the Run mode, change the menu level access code back to "00" or "01" as previously shown.

#### Menu "01" (Run — Limited Access Mode)

The only parameter that can be changed at this menu level is the Setpoint Value, using the appropriate Raise  or Lower  key. To set or change other parameters, the operator must access another menu level by pressing and holding the Parameter/Access  key for 11 seconds.

#### Menu "00" (Run — "Key Lock" Lockout Mode)

This menu is automatically active when power is first applied. Both display windows are illuminated; however, access is denied to all parameters. To set or change parameters, the operator must access another menu level as instructed previously.

## Operation

### Notes on Alarms

Either [ OUT 1 ] or [ OUT 2 ] in menu level "05" (but not both) may be configured as an alarm [ ALr ] if your CN8502 controller was ordered with an "R", "DC" or "T" type of output module. When one of the two available Outputs is configured as an alarm, the other Output may be used for control .

When the controller is provided with the Dual Alarm option, two independent alarms are automatically enabled for both outputs. DO NOT USE THE [ ALr ] SETTINGS FOR [ OUT 1 ] OR [ OUT 2 ]. Otherwise, follow the regular instructions for configuring the Dual Alarms in menu level "05":

The dual-output CN8502 offers a unique capability that provides for the activation of two software alarms (in addition to the dual alarms) to monitor a total of four possible alarm conditions. To enable these software alarms, set the [ OUT 1 ] and [ OUT 2 ] parameter(s) in menu level "05" to on/off mode [ Ht.O ], [ CL.O ] or [ On.F ]. Set the Setpoint Value to your first alarm point. Switch to menu level "02" and set Spread [ C.Spr ] or [ Spr.2 ] to the desired deviation value from the first alarm point. Set [ H.HYS ] and [ C.HYS ] to 1. Then switch to menu level "03" and set the desired values for the third and fourth alarm points at [ ALr 1 ] and [ ALr 2 ], respectively. Press the Mode  key to resume operation.

## Operation

### Available Alarm Types [ A1.P.d. ] [ A2.P.d. ]

Selectable at menu level "05", as either Process [ Pr ] or Deviation [ dE ] and either high or low [ A1.HL ] or [ A2.HL ].

Process Alarm: Activates at preset value independent of setpoint. "High" process alarm activates at and above alarm setting. "Low" process alarm activates at and below alarm setting.

Deviation Alarm: Activates at a preset deviation value from setpoint. "High" or "Low" deviation alarm activates above or below setpoint according to the preset deviation value.

### Latching Alarms

The CN8500 Series's alarms may also be configured as latching alarms by selecting "LAT" in the [ A1.O.P. ] or [ A2.O.P. ] parameter selection at menu level "05".

*When a latching alarm has been activated and the alarm condition has been removed, the Mode  key must be pressed to unlatch the alarm.*



Figure 10. CN8500 Series Controller Menu Hierarchy

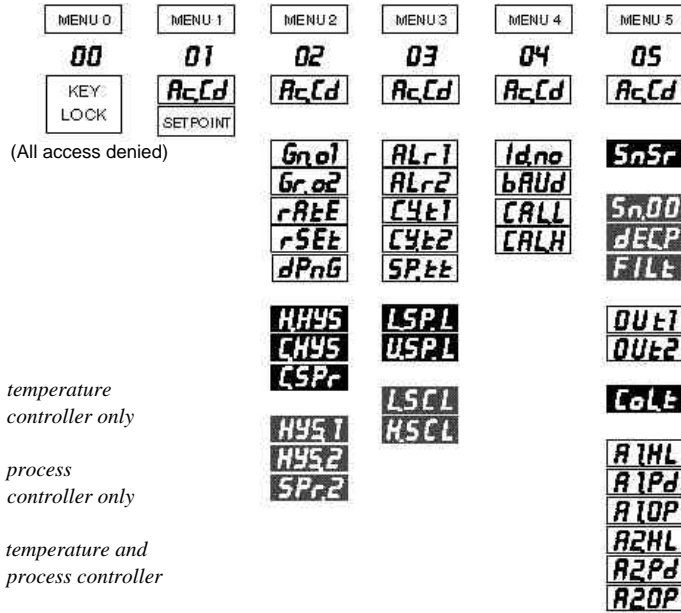

## Parameter Descriptions

Note: Menu parameters shown in regular type-face appear only for temperature input types; menu parameters in boldface are for linear/process input types.

The Digital Filtering setting [ FILt ] on the CN8500 Series process controller allows the operator to compensate for noise which may cause the last digits of the PV display to become unstable. Sampling rate is not affected. The settings are time constants, in seconds, with 0.1 equivalent to "no filtering."

## CN8500 Series Temperature/Process Controller

Menu "05"	Parameter	Selection	Code
Display	Parameter	Thermocouple:	
SnSr	Sensor type	K	c.A
		J	J
		N	n
		R	r
		T	t
		S	S
		Platinel II	PLII
		RTD	P (1 deg. resolution)
		RTD (decimal range)	d (0.1 deg. resolution)
OUT1	Output 1 action	Heat PID	Ht.P
		Heat On/Off	Ht.O
		Alarm	ALr
OUT2	Output 2 action	Cool PID	CL.P
		Cool On/Off	CL.O
		Alarm	ALr
SN.00	Input Zero Level	Unsuppressed	U.Su
		Suppressed	Su
Dec.P	Decimal Point		999, 99.9, 9.99
FILt	Digital Filtering		0.1, 1, 10
OUT1	Output 1 action	PID	Pid
		On/Off	On.F
		Alarm	ALr
OUT2	Output 2 action	PID	Pid
		On/Off	ON.F
		Alarm	ALr

## Parameter Descriptions

CoL.t*	Cooling type	Water Normal	H2o (non-linear output) nor (linear output)
A1.H.L.	Alarm 1 select	Enable	Lo/HI
A1.P.d.	Alarm 1 type	Process/Deviation	Pr/dE
A1.O.P.	Alarm 1 output	Off/Normal/Latching	OFF/nor/LAT
A2.H.L.	Alarm 2 select	Enable	Lo/HI
A2.P.d.	Alarm 2 type	Process/Deviation	Pr/dE
A2.O.P.	Alarm 2 output	Off/Normal/Latching	OFF/nor/LAT
UnIt	Measurement units	°F or °C	F/C

\* For water-cooled extruders, select H2o.

### Menu "04"

Display Id.no	Parameter Device ID number (remote communications)	Allowable Values
bAUd	Baud, parity and data bit selection	See chart below
CAL.L	Calibration low	Preset at factory
CAL.H	Calibration high	Preset at factory

### Available Communications Settings

Display	Description			
	Baud Rate	Parity	Data Bits	Stop Bits
3.o.7	300	odd	7	2
6.o.7	600	odd	7	2
12.o.7	1200	odd	7	2
24.o.7	2400	odd	7	2
3.n.8	300	none	8	1
6.n.8	600	none	8	1
12.n.8	1200	none	8	1
24.n.8	2400	none	8	1



## Parameter Descriptions



Menu "03"		Parameter	Allowable Values
Display	ALr1	Alarm 1 preset	Dependent on sensor range
	ALr2	Alarm 2 preset (if ordered)	Dependent on sensor range
	CY.t1	Cycle time output 1	00 to 120 seconds
	CY.t2	Cycle time output 2	00 to 120 seconds
	SP.tt	Setpoint target time (ramp-to-setpoint)	Off/1 to 100 minutes
	L.SP.L	Lower setpoint limit	Dependent on sensor range
	U.SP.L	Upper setpoint limit	Dependent on sensor range
	L.SCL	Low scale setting	-1999 to 9999
	H.SCL	High scale setting	-1999 to 9999
Output Type (seconds)	Recommended Setting		
R (5A/3A)	15 to 120		
F (4-20 mA)	MUST be set to 00		
DC (pulsed 20 Vdc)	00 to 120		
T (S.S. relay)	15 to 120		

*When changing thermocouple types, be sure to check/adjust upper and lower setpoint limit values.*

*Note: Menu parameters shown in regular type-face appear only for temperature input types; menu parameters in boldface are for linear/process input types.*

*Setting output cycle time to "00" initiates a 200 ms timebase.*

**Notes on Setpoint Target Time:** The [ SP:tt ] parameter allows the operator to enter a time delay for the process to reach setpoint temperature (ramp to setpoint), from disabled [ OFF ] or 1 to 100 minutes. When enabled, the ramp sequence starts on power-up. The ramp-to-setpoint feature will also be initiated whenever a new setpoint target time is entered AND the Setpoint Value is 5° F or more from the current process temperature. In operation, the controller's lower window display will flash  or  to indicate that it is "ramping" up or down to setpoint. The Setpoint Value cannot be changed during this procedure. After it is finished, the operator can adjust the setpoint temperature to the desired value.

While in ramp startup, the ramp-to-setpoint mode can be aborted and the controller returned to regular operation by pressing the Parameter/Access  key until parameters are displayed and then pressing the Mode  key once.

# Parameter Descriptions

Menu "02"	Parameter	Allowable Values
Display	Parameter	
Gn.o1	Gain Output 1 (PID heat gain)	00 to 400 <i>(This value may exceed 400 during autotuning.)</i>
Gr.o2	Gain Ratio Output 2 (PID cool gain ratio)	0.0 to 2.0
H.HYS	Heat Hysteresis	01 to 100°
C.HYS	Cool Hysteresis	01 to 100°
HYS1	Output 1 Hysteresis	1 to 100 units
HYS2	Output 2 Hysteresis	1 to 100 units
SPr.2	Spread Adjustment, Output 2	0 to 100 units
C.SP	Cool Spread	0 to 100°
rAIE	PID rate	00 to 900 seconds
rSEt	PID reset	00 to 3600 seconds
dPnG	Damping (see notes)	Lo, nL, Hi, Off

Notes on Damping: The damping parameter is an autotune feature that enables more precise control of setpoint overshoot during recovery from process upsets in which thermal or transfer lag is a factor. See Figure 12. Use the correct setting prior to autotuning to compensate for power and load/sensor coupling characteristics.

- Lo = Fast recovery with slight overshoot. For single-lag processes.  
*Ex. Adequate power and excellent load/sensor coupling.*
- nL = Normal recovery with no overshoot. For two-lag processes.  
*Ex. Properly sized heaters or components and good load/sensor coupling.*
- Hi = Slow recovery with no overshoot. For three-lag processes.  
*Ex. Overpowered with multiple lags. Poor load/sensor coupling.*
- Off = Autotune disabled; manual output control.

*Setting Rate (Derivative) or Reset (Integral) to [ 00 ] disables that aspect of PID control. The ratio for non-zero settings of rate-to-reset is limited to a minimum of 1:4, i.e., Reset value cannot be set any lower than four times Rate.*

*The parameters of Heat Hysteresis, Cool Hysteresis and Cool Spread are only available when Output 1 and/or Output 2 are set to on/off mode [Ht.O] or [CL.O]. They replace Gain Output 1 and Gain Ratio Output 2, respectively.*

*Note: Menu parameters shown in regular typeface appear only for temperature input types; menu parameters in boldface are for linear/ process input types.*

Figure 11. Typical Lag Processes

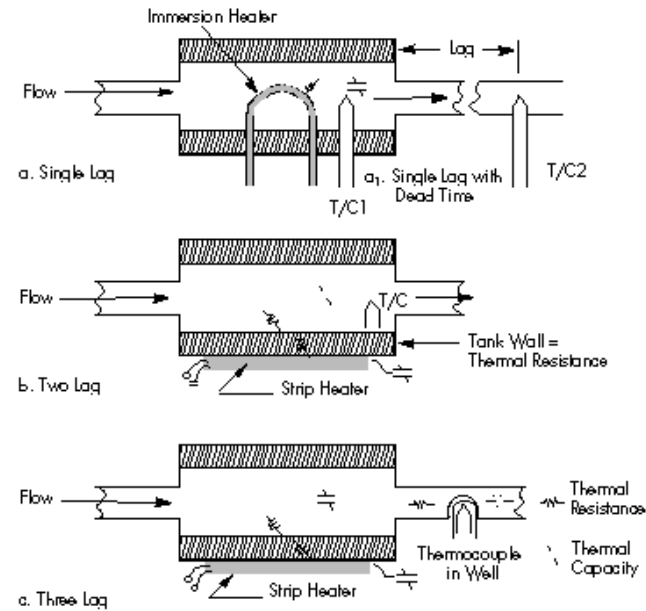

## Tuning Procedures

*For best results in tuning the temperature controller, the setpoint value should be at least 100°F above or below ambient temperature.*

*While some processes other than heat or cool applications may respond successfully to autotuning procedures, the controller must be manually tuned for most non-temperature processes.*

### Introduction

The CN8500 Series is an “on demand” autotuning controller that automatically sets PID parameter values (Proportional Band, Reset and Rate) before the process reaches setpoint. A damping setting (menu level “02”) MUST be selected for autotuning to take place. The controller may also be tuned manually (see page 31).

### Autotuning the CN8500 Series Temperature Controller

- 1) With the power off and the process at ambient, apply power and immediately put the controller in Standby mode by holding the **≡** key for four seconds until [ StbY ] flashes in the lower display window.
- 2) Enter the desired Setpoint Value using the appropriate Raise **▲** or Lower **▼** key. [ StbY ] will continue to flash.
- 3) If controller is in menu level “00” or “01”, hold the Parameter/ Access **↻** key for 11 seconds until [ Ac.Cd ] appears. Then change to menu level “05”. Otherwise, press the **↻** key once and use the **▲** key to select menu level “05”.
- 4) Press the Parameter/Access **↻** key twice until [ SnSr ] is displayed to make sure that the proper sensor has been selected. Then set the controller’s heating mode or alarm functions by pressing the Parameter/Access **↻** key again

## Tuning Procedures

until [ OUT1 ] is displayed. (If you scroll past it, just continue scrolling until the parameter menu repeats.) Using the appropriate Raise **▲** or Lower **▼** key, select the one of the following settings according to the requirements of your process. *Note: For autotuning, at least one output MUST be set to PID mode.*

Mode	Output 1 (Heat) Setting	Output 2 (Cool) Setting
PID	[ Ht.P ]	[ CL.P ]
On/Off	[ Ht.O ]	[ CL.O ]
Alarm	[ ALr ]	[ ALr ]

Press the Parameter/Access **↻** key again to step to output 2 [ OUT2 ]. Repeat the selection process for cooling mode or alarm. (If only one output is PID, set the other output to either On/Off or Alarm.)

- 5) Press the Parameter/Access **↻** key again to display the Cooling Type parameter [ CoL.t ], and select either Normal/Linear output [ nor ] or Water-Cooled/Non-Linear output [ H2o ].
- 6) Exit menu level “05” by pressing the Mode **≡** key once. The lower window will flash [StbY]. Now press the Parameter/Access **↻** key once. The lower window will display [Ac.Cd ] and [ 05 ]. Press the Lower **▼** key twice to select menu level “03”.
- 7) Press the Parameter/Access **↻** key and select Cycle Time for Output 1 [ CY.t1 ] and Cycle Time for Output 2 [ CY.t2 ]. For Control Output type R or T, enter “15”. For Control Output type F or DC, enter “00”.

## Tuning Procedures

Before autotuning can take place, you must select a damping setting. If the damping parameter does not appear on the menu, you have not selected a PID option for outputs 1 or 2. Refer back to step (4) and select the proper setting(s).

During autotuning, the process temperature will gradually cycle from ambient to setpoint. When autotuning is complete, the [ tUnE ] display will stop flashing and the Gain, Rate and Reset numbers "learned" will be kept in memory for subsequent startups.

- 8) Press the Parameter/Access key until Setpoint Target Time [ SP.tt ] is displayed. Select [ OFF ].
- 9) Press the Mode  $\equiv$  key once. The lower window will again flash [StbY]. Press the Parameter/Access  $\curvearrowright$  key once and the lower window will display [Ac.Cd ] and [ 03 ]. Press the Lower  $\blacktriangledown$  key once to select menu level "02".
- 10) Press the Parameter/Access  $\curvearrowright$  key and scroll through the displayed parameters. If Gain Ratio [ Gr.o2 ] is displayed, set it to [ 1.0 ]. Otherwise, continue scrolling until [dPnG ] appears. Set Damping initially to Normal [ nL ]. (This setting may have to be changed later. See *Notes on Damping*, page 26).
- 11) Press and hold the Mode  $\equiv$  key until [ tUnE ] flashes in the lower display window. The controller is now autotuning. When it stops flashing, the autotuning procedure is completed and the controller is ready for your process. As a security measure, you may wish to place the controller in Key Lock "00" or Limited Access "01" Run mode by changing menu levels as instructed previously.

Note: Re-tune controller only from ambient temperature.

Autotuning will not function when process is at setpoint.

**Figure 12. Typical "Autotune" Temperature Profile.**

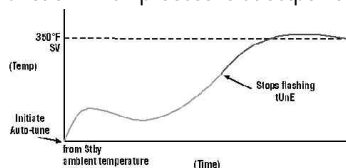

## Tuning Procedures

If overcooling exists on heat/cool processes after autotuning, decrease Gain Ratio [ Gr.o2 ] in steps of 0.1 until oscillation is minimal. If cooling is sluggish, increase the value in steps of 0.1 until optimum results are achieved.

Gain ratio [ Gr.o2 ] is the cooling gain expressed as a factor of the heating gain.

Ex. [ Gn.01 ] = 100  
Cooling Gain = 50  
[ Gr.o2 ] = .5

## Manual Tuning Procedure - Temperature Controller (Zeigler-Nichols PID Method)

This tuning method may be used if the spread between ambient temperature and process operating temperature is small. For best results, the use of a recording device is suggested when tuning with this method.

- 1) Disable any cooling device used.
- 2) Apply power and place the controller in Standby by pressing and holding the Mode  $\equiv$  key for four seconds.
- 3) Using Raise  $\blacktriangle$  or Lower  $\blacktriangledown$  key, adjust setpoint to desired value.
- 4) Access menu level "02" following instructions given previously.
- 5) Using the Parameter/Access  $\curvearrowright$  key, index to Heat Gain [ Gn.o1 ]. Select [ 01 ].
- 6) Index to Gain Ratio [ Gr.o2 ] and select [ 1.0 ].
- 7) Index to Rate [ rAtE ] and select [ 00 ].
- 8) Index to Reset [ rSEt ] and select [ 00 ]. Note: In order to set Reset to [ 00 ], Rate must first be set to [ 00 ].
- 9) Change to menu level "03".
- 10) Index to Cycle Time 1 [ CY.t1 ] and select the timebase, in seconds, appropriate to the device being controlled.



## Tuning Procedures

- 11) Repeat for Cycle Time 2 [ CY.t2 ].
- 12) Change to menu level "05".
- 13) Set Cooling Type [ CoL.t ] to [ nor ].
- 14) Press the Mode **≡** key once. Setpoint Value will be displayed. The recording device should now be tracking process temperature.
- 15) Double the Gain [ Gn.o1 ] until a small, sustained oscillation is visible on the recording device's trace.
- 16) Measure the period of one cycle of oscillation ("T" on the diagram below).

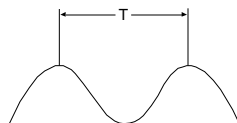

- 17) Divide the period of oscillation (T) by eight (8). The resulting number is the correct Rate time [ rAtE ] in seconds. Multiply this number by four. This is the correct Reset time [ rSEt ] in seconds.
- 18) Multiply the gain (from step #15) by 0.6 and enter this number as Gain [ Gn.o1 ].
- 19) Enable the cooling device. If overcooling exists, decrease the Gain Ratio [ Gr.o2 ] in steps of 0.1 until temperature oscillation stops. If cooling is sluggish, increase the Gain Ratio in steps of 0.1 until optimum results are achieved.

## Tuning Procedures

### Manual Tuning Procedure - Process Controller (Zeigler-Nichols PID Method)

A chart recorder to monitor the process variable is required. The controller must be properly scaled and filtering set as instructed previously.

- 1) Apply power and place the controller in Standby by holding the Mode **≡** key for four seconds.
- 2) Adjust the setpoint to the desired value.
- 3) Access menu level "05" and select one output: [ OUT 1 ] for reverse-acting control or [ OUT 2 ] for direct-acting control. Set the active output to PID [ Pid ] and the unused output to Alarm [ ALr ] or On/Off [ On.F ].
- 4) Access menu level "02" and set [ Gn.01 ] to 1.0; [ Gr.o2 ] to 1.0; and [ rAtE ] and [ rSEt ] to "00".
- 5) Press the Mode **≡** key for four seconds until display flashes [ tUnE ]. Press the Mode key for another four seconds and the process will run in closed loop mode.
- 6) While monitoring the chart, increase Gain [ Gn.o1 ] by doubling the gain number until the process variable becomes unstable. Then decrease Gain until the process oscillations are sustained, neither increasing nor decreasing in amplitude as a result of momentary setpoint change.
- 7) Multiply the Gain from Step (6) by 0.6.
- 8) Measure the period of one complete cycle of oscillation, "T", in seconds.

Calculate and enter these numbers:

Rate [ rAtE ] = T/8  
 Reset [ rSEt ] = T/2  
 Gain [ Gn.01 ] = Gain from Step (6)

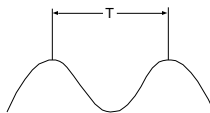

On noisy processes, where Rate cannot be used:  
 Gain [ Gn.01 ] = from Step (6) x 0.45  
 Reset [ rSEt ] = T/1.2



## Options

*In manual control mode, error conditions such as A/D errors and open or reversed sensors will be ignored.*

### Auto/Manual Operation (Standard)

To put the controller in manual mode, set the damping [dPnG] parameter in menu level "02" to [ OFF ]. Press and hold the Mode  key for four seconds until the lower display window flashes [ StbY ]. Hold down the Mode key for another four seconds to initiate manual operation. The lower display window will flash percentage of output power, from 100 to -100, alternating with the output controlled (temperature controllers will flash [ HEAt ] or [ CoOL], process controllers will flash [ OUT1 ] or [ OUT2 ].) To take the controller out of manual mode, press and hold Mode  key to four seconds.

*Note: The CN8500 Series controller can be ordered with only one of the following options installed per instrument. These options cannot be field-installed.*

### Remote Setpoint Select

If your CN8500 Series controller was ordered with this option, you may select either of two setpoints for your process. The second setpoint can be enabled only by an external switch or signal, according to your ordering specifications. The "F2" LED on the front panel will illuminate when a second setpoint is selected.

## Options

Option Part #	Description
-RSP1	External switch wired to terminals 6 and 7 Switch Open: Normal operation, first setpoint enabled Switch Closed: Second setpoint enabled Setpoint Adjustments: Made from front panel
-RSP2	External switch wired to terminals 6 and 7 Switch Closed: Normal operation, first setpoint enabled Switch Open: Second setpoint enabled Setpoint Adjustments: Made from front panel
-RSP3	0-5 Vdc signal at pins 6 and 7 0 Vdc: First setpoint enabled 5 Vdc: Second setpoint enabled Setpoint Adjustments: Made from front panel

Maximum Input Impedance: 400 ohms @ +5 Vdc , 5 mA

**Figure 13. Wiring Diagram for Remote Setpoint Select Option**

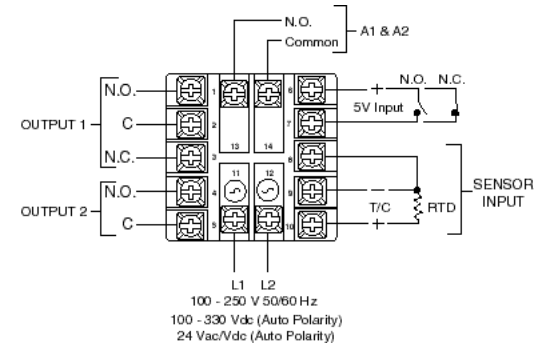

## Options

These output values are linear with and dependent upon the sensor being used, i.e., the lowest value of the sensor's output range corresponds to zero or low for the output function.

For voltage output, a jumper must be installed between terminals 13 and 14.

**Figure 14. Wiring Diagram for Process Variable Retransmission**

### Recorder Output (PV transmission)

If your CN8500 Series controller was ordered with this option, you may retransmit the signal representing the process variable for analysis or storage to an external device that accepts analog input, such as a chart recorder, datalogger, or process control computer. These outputs are:

- Suppressed: 1-5 Vdc/4-20 mAdc
- Unsuppressed: 0-5 Vdc/0-20 mAdc
- Ordering Suffix: -PV1 = 4 to 20 mA  
-PV2 = 0 to 5 Vdc

- $I_{out}$  (current output) = 0-20 mA/4-20 mA
- Voltage Headroom = 8 Vdc (standard) ; 18 Vdc (for multiple recording devices)
- $V_{out}$  (voltage output) = 0-5Vdc/1-5 Vdc
- $I_{out Max}$  = 20 mA

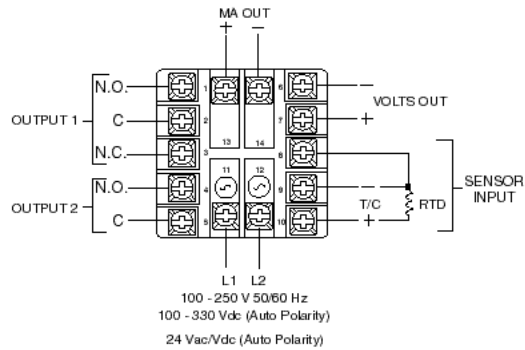

## Options

### Transducer Excitation

The transducer excitation voltage option is used to produce a constant dc voltage of Vdc out to an external device, eliminating the need for an additional external power supply.

- Maximum Current: 22 mA
- Output Voltage: 15 Vdc
- Ambient Temperature: 0 to 55° C (32 to 131° F)
- Ordering Suffix: -XP1

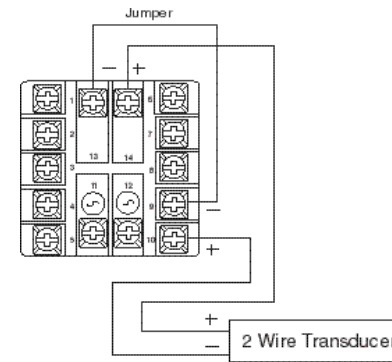

**Figure 15. Wiring Diagram for Transducer Excitation**

## Digital Communications

Two communication options are available for the CN8500 Series which allow interfacing to remote devices utilizing the most common industry standards, RS232 and RS485.

### **WARNING**

Signal ground only. Grounding to frame may damage the controller and void warranty.

### **RS232**

This method allows bidirectional data transfer via a three-conductor cable consisting of signal ground, receive input and transmit output. It is recommended for communication distances less than fifty feet between the computer terminal and the instrument. Note: Multiple instruments cannot be connected to the same port.

The RS232 port is optically isolated to eliminate ground loop problems. Typically, "Data Out" of the computer/terminal connects to the "RCV" terminal. "Data In" connects to the "XMT" terminal. If shielded cable is used, it should be connected to the frame ground at one end only. Signal ground is to be connected at appropriate ground terminals

### **RS485**

The RS485 multipoint capability allows up to 32 controllers to be connected together in a half-duplex network or up to 100 controllers with an appropriate communications repeater. This method allows bidirectional data transfer over a shielded twisted pair cable. The twisted pair cable is a transmission line; therefore, terminating resistors are required at the most distant ends of the line to minimize reflections (typically 60 ohms from each line to signal ground). The RS485 circuit is fully optically isolated, eliminating ground loop problems. Parallel drops from the transmission lines should be kept as short as possible; however, the line may be daisy-chained at

## Digital Communications

each controller. The polarity of the line is important and each device will specify an "A" (+) and "B" (-) connection.

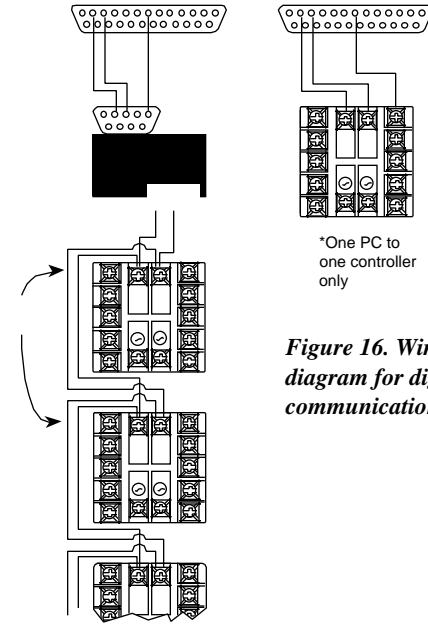

**Figure 16. Wiring diagram for digital communications.**

**Table 1. Communications Parameter List (Temperature Controller)**

Parameter No.	Description	Display	Minimum	Maximum
00	Process Value	nnnn	Sensor Dependent	
01	Setpoint	nnnn	Low Limit	High Limit
02	Access Code	Ac.Cd	00	05
03	Gain Output 1	Gn.o1	00	400
04	Gain Ratio 2	Gr.o2	0.0	2.0
05	Rate	rAtE	00	900
06	Reset	rSEt	00	3600
07	Heat Hysteresis	H.HYS	01	100
08	Cool Hysteresis	C.HYS	01	100
09	Cool Spread	C.SP	00	100
10	Damping	dPnG	00	Low/Normal/High
11	Alarm 1	ALr1	Range Dependent	
12	Alarm 2	ALr2	Range Dependent	
13	Cycle Time 1	CY.t1	00	120
14	Cycle Time 2	CY.t2	00	120
15	Setpoint Target Time	Sp.tt	00 (OFF)	100
16	Low Setpoint Limit	L.SP.L	Sensor Dependent	
17	High Setpoint Limit	U.SP.L	Sensor Dependent	
18	Controller ID	Id.no	00	99
19	Baud Rate	bAUd	300	2400

**Table 2. Communications Parameter List (Process Controller)**

Parameter No.	Description	Display	Minimum	Maximum
00	Process Value	nnnn	Low Scale	High Scale
01	Setpoint	nnnn	Low Scale	High Scale
02	Access Code	Ac.Cd	00	05

03	Gain Output 1	Gn.o1	00	400
04	Gain Ratio 2	Gr.o2	0.0	2.0
05	Rate	rAtE	00	900
06	Reset	rSEt	00	3600
07	Hysteresis 1	HYS.1	01	100
08	Hysteresis 2	HYS.2	01	100
09	Spread 2	SPr.2	00	100
10	Damping	dPnG	00	Low/Normal/High
11	Alarm 1	ALr1	Low Scale	High Scale
12	Alarm 2	ALr2	Low Scale	High Scale
13	Cycle Time 1	CY.t1	00	120
14	Cycle Time 2	CY.t2	00	120
15	Setpoint Target Time	Sp.tt	00 (OFF)	100
16	Low Scale	L.SCL	-1999	9999
17	High Scale	H.SCL	-1999	9999
18	Controller ID	Id.no	00	99
19	Baud Rate	bAUd	300	2400

**Table 3. Serial Communications Data Format**

Baud Code	Baud Rate	Parity	Data Bits	Stop Bits
0	300	Odd	7	2
1	600	Odd	7	2
2	1200	Odd	7	2
3	2400	Odd	7	2
4	300	None	8	1
5	600	None	8	1
6	1200	None	8	1
7	2400	None	8	1

## Interface Examples

This section describes the protocol for communication between an CN8500 Series controller and either a video display terminal or computer (referred to below as "the host"). Message strings may be of two types — commands to controller or responses from controller.

## General Comments

One host and multiple controllers may be interconnected on a single bus. The host may send commands to any controller and may receive responses from any controller. Each controller on the bus is assigned an identification code between 00 and 99. No two controllers on a given bus may have the same identification code. Controllers are not capable of communicating with other controllers.

Every valid message begins with a pound-sign (#) character.

Every valid message ends with a carriage-return (<CR>) character.

A valid message is composed of: Start Message, Controller ID Code, Command, Parameter and Data.

Every response begins with a line-feed (<LF>) character and ends with a carriage-return, line-feed pair (<CRLF>).

## Caution:

*Modifying parameter #19 (Baud Rate) by host may cause loss of data link.*

## SAMPLE

### BASIC Program:

```

10 OPEN "COM2: 2400, N, 8,
1, CS, DS" AS #1
20 PRINT "WHAT IS
COMMAND",
30 INPUT AS
40 PRINT #1, AS
50 INPUT #1, B#
60 PRINT "THE RESPONSE
IS: "; B$
70 PRINT
80 GOTO 20
90 CLOSE
    
```

Figure 17. General Communications Message Format

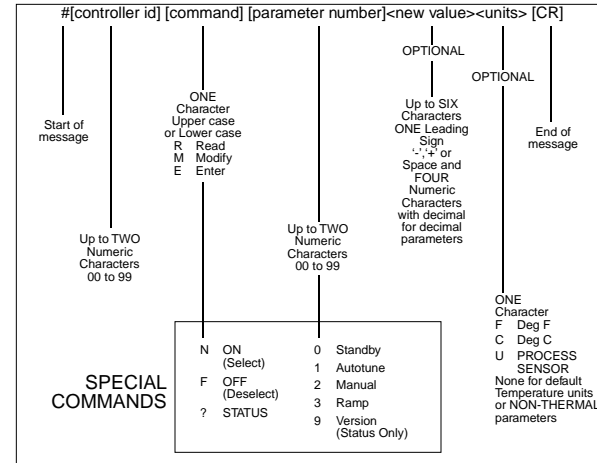

Example: For Standby "On", type #01N0[CR].

Figure 18. Sample Communications Commands

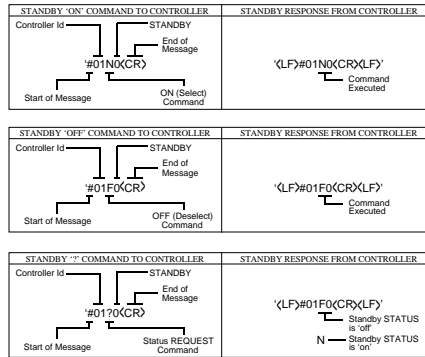
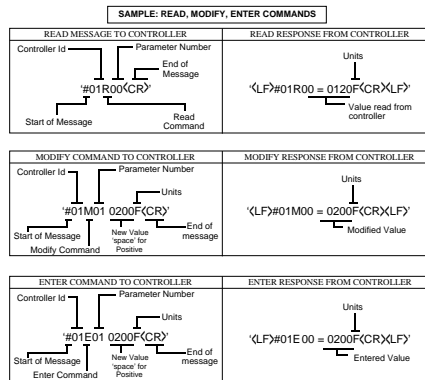

Figure 19. Requesting a Parameter from a Controller









**Caution:**  
 Wherever possible, avoid using the "Enter" command and use "Modify" or "Read" instead. The "Enter" command makes permanent changes to the NOVRAM in the CN8500 Series's microprocessor, and after accepting a maximum capacity of 100,000 "Enter" statements, it will have to be returned to the factory and replaced.

1. The controller will respond with <LF>ERROR<CR><LF> for messages containing invalid/incorrect commands, parameter number or data (with decimal, if needed).
2. Process Value is a read-only parameter; therefore, a modify or enter command for Process Value will result in a <LF>ERROR<CR><LF> response.
3. For modify or enter command: if the new value is out of the parameter's range, the controller will default to the highest or lowest allowable parameter value.
4. Parameters with decimal data must contain a decimal character in the data portion of the message.
5. Ramp "on" command (Setpoint Target Time) will not be executed if ramp time is set to zero or absolute deviation between Setpoint and Process Value is less than or greater than 5 temperature or process units.
6. Autotune, manual and ramp commands are mutually exclusive, i.e., selecting manual while autotune is enabled will abort the autotune mode.
7. If the controller is in Standby mode, selecting autotune, manual or ramp will de-select Standby.
8. Setpoint should not be modified while the controller is in autotune or ramp mode.
9. The Setpoint Value enter command should not be executed while the controller is in manual mode.

## Recalibration

*Only qualified individuals utilizing the appropriate calibration equipment should attempt recalibration of the controller.*

Your CN8500 Series has been calibrated at the factory, and need not be adjusted during the life of the controller unless sensor type is changed from thermocouple to RTD, or vice versa. In the event that recalibration is warranted, follow these procedures.

- 1) Access menu level "05" as previously instructed and select the sensor type.
- 2) Use a calibrator with a range appropriate for the unit to be calibrated and set the range, and a low or zero value.
- 3) Access menu level "04" and then the Parameter/Access  key until [ CAL.L ] is displayed. Then, press the Raise  or Lower  key until the number in the controller's upper (PV) display window matches the indicated value of the calibration instrument.
- 4) Enter a value on the calibration instrument corresponding with the high-end value of the sensor range (span).
- 5) Again, in menu level "04", press the Parameter/Access  key until [ CAL.H ] is displayed. Then, press the Raise  or Lower  key until the number in the controller's upper (PV) display window matches the indicated value of the calibration instrument.
- 6) Repeat steps 3 through 5 until all readings agree.
- 7) Return the controller to regular operation by pressing the Mode  key.

## Error Codes

Display	Problem	Action
[ Err.H ]	Open sensor	Check sensor and wiring Check type of sensor Recalibrate
[ Err.L ]	Reversed sensor	Check sensor and wiring Check type of sensor Recalibrate
[ Err.O ]	A/D error	Return to factory
[ Err.J ]	A/D error	Return to factory
----	Display out-of-range	Sensor over- or under-range



# Technical Specifications

## Performance

Accuracy	±0.2% of full scale, ± one digit
Setpoint Accuracy	1 °/0.1°
Temperature Stability	5 µV/°C max; 3 µV/°C typical
TC Cold End Tracking	0.05° C/°C ambient
Noise Rejection	Common mode >100 dB Series Mode >70 dB
Process Sampling Rate	10 Hz (100 ms)

## Input Types

Thermocouple	6 (K, J, N, R, T, S) Maximum lead resistance 100 ohms for rated accuracy
RTD	Platinum 2- and 3-wire, 100 ohms at 0° C, DIN curve standard (0.00385)
DC Voltage	0-50 mV/10-50 mV, 0-5 V/1-5 V, 0-10V/2-10 V
DC Current	0-20 mA/4-20 mA

## Input Impedances

0-50 mV/10-50 mV:	1 K ohm ± 1%
0-5/1-5 V:	100 K ohms ± 1%
0-20 mA/4-20 mA:	2.5 ohms ± 1%
0-10 V/2-10 V:	200 K ohms

## Input Ranges and Resolutions

Input Code	Type	Range	Resolution
TC	J Iron-Constantan	-18 to 760° C 0 to 1400° F	1° C 1° F
	K CHROMEGA®-ALOMEGA®	-18 to 1349° C 0 to 2460° F	1° C 1° F
	T Copper-Constantan	-129 to 316° C -200 to 600° F	1° C 1° F
	N OMEGALLOY®	-18 to 1299° C 0 to 2370° F	1° C 1° F
	R Pt/13%Rh-Pt	-18 to 1760° C 0 to 3200° F	1° C 1° F
	S Pt/10%Rh-Pt	-18 to 1760° C 0 to 3200° F	1° C 1° F
RTD	RTD 2, 3-wire, 100-ohm Pt	-200 to 850° C -328 to 1562° F	1° C 1° F
	RTD 2, 3-wire, 100-ohm Pt	-128.8 to 232.2° C -199.0 to 450.0° F	0.1° C 0.1° F
V5	1 to 5 V 0 to 5 V	Scalable (-1999 to +9999) Scalable (-1999 to +9999)	Selectable Selectable
V10	2 to 10 V 0 to 10 V	Scalable (-1999 to +9999) Scalable (-1999 to +9999)	Selectable Selectable
MV	10 to 50 V 0 to 50 V	Scalable (-1999 to +9999) Scalable (-1999 to +9999)	Selectable Selectable
MA	4 to 20 mA 0 to 20 mA	Scalable (-1999 to +9999) Scalable (-1999 to +9999)	Selectable Selectable

## Technical Specifications

### Outputs

#1	Reverse acting (heating) [alarm]
#2 (CN8502 only)	Direct acting (cooling) [alarm]
R1, R2	Relay, 5 A @ 120 Vac resistive 3 A @ 240 Vac
F1, F2	4-20 mA <sub>dc</sub> , 500 ohms max.
DC1, DC2	20 V <sub>dc</sub> pulsed
T1, T2	Solid-state relay, 120/240 Vac, zero voltage-switched, 1 A continuous, 10 A surge @ 25° C

### Alarms

Electromechanical relay, 5 A @ 120 Vac,  
3 A @ 240 Vac (Output 1 OR 2 only)

Dual-Alarm option: Two solid-state  
relays, 120/240 Vac, zero voltage-  
switched, 1 A continuous, 10 A surge  
@ 25°C

### Control Characteristics

Setpoint Limits	Limited to configured range
Alarms	Adjustable for high/low; selectable process or deviation
Rate	0 to 900 seconds
Reset	0 to 3600 seconds
Cycle Time	0.2 (zero setting) to 120 seconds
Gain	0 to 400
Gain Ratio	0 to 2.0 (in 0.1 increments)

## Technical Specifications

Control Hysteresis	1 to 100 units (on/off configuration)
Cool Spread, Output 2 (Temperature Controller)	0 to 100° F/C (above setpoint)
Spread 2, Output 2 (Process Controller)	0 to 100 units (above setpoint)
Damping	Selectable (low, normal, high, off)
Setpoint Target Time (Ramp-to-Setpoint)	0 (off) to 100 minutes
Autotune	Operator-initiated from front panel
Manual	Operator-initiated from front panel

### General

Line Voltage	115 to 230 V ±10%, 50-60 Hz 115 to 300 V <sub>dc</sub> ±10% (Auto-Polarity) 24 Vac/dc (optional)
Display	Dual, 4-digit 0.36" (9.2 mm) LED display Process Value: Orange Setpoint Value/Menu: Green
Power Consumption	Less than 6 VA (@ 120/240 Vac)
Weight	< 8 oz (< 226.8 g)
Panel Cutout	1.771" x 1.771" (45 mm x 45 mm)
Depth Behind Panel	3.937" (100 mm)
Front Panel Rating	NEMA 4X
Operating Temperature	32 to 131° F (0 to 55° C)
Humidity Conditions	90% R.H. max., non-condensing
Parameter Retention	Solid-state, non-volatile memory
Connections	Input and output via barrier strip with locking terminals
Contacts	Twin bifurcated

## Ordering Numbers

### *CN8500 Series*

#### Ordering Number

CN8501

CN8502

#### Description

1/16 DIN Single  
output controller

1/16 DIN Dual  
output controller

#### Output Type - Ordering Suffix

	<u>CN8501</u>	<u>CN8502</u>
5 A relay	-R1	-R2
1 A SSR	-T1	-T2
4-20 mA	-F1	-F2
20 Vdc pulse	-DC1	-DC2

#### *Options (cannot be field-installed)*

#### Description

#### Ordering Suffix

Dual alarms	-A
RS-232 communications	-C2
RS-485 communications	-C4
4-20 mA recorder output	-PV1*
0-5 Vdc recorder output	-PV2*
Remote switch closed, with one alarm	-RSP1*
Remote switch open, with one alarm	-RSP2*
0 or 5 Vdc remote setpoint with 1 alarm	-RSP3*
Transducer power supply	-XP1*

\*Not available for voltage or current input models (input codes MV, V5, V10, or MA)

## Ordering Numbers

### *CN8500 Series Option Compatibility*

When the following features are used together, connections to all but one must float, i.e., no more than one in each group can be referenced to any ground.

#### Group 1

Transducer excitation

F or DC output

Communications

DC alarms (except floating transistor)

Digital input (remote setpoint select)

Aux. output (P.V. retransmit)

#### Group 2

Any input

Analog setpoint

Aux. output (P.V. retransmit)

Note: Auxiliary output (P.V. retransmit) and transducer excitation cannot be used together in any configuration.

## Warranty Information



### WARRANTY / DISCLAIMER

OMEGA ENGINEERING, INC. warrants this unit to be free of defects in materials and workmanship for a period of 25 months from date of purchase. OMEGA Warranty adds an additional one (1) month grace period to the normal two (2) year s product w arranty to cover handling and shipping time. This ensures that OMEGA's customers receive maximum coverage on each product. If the unit should malfunction, it must be returned to the factory for evaluation. OMEGA's Customer Service Department will issue an Authorized Return (AR) number immediately upon phone or written request. Upon examination by OMEGA, if the unit is found to be defective it will be repaired or replaced at no charge. OMEGA's WARRANTY does not apply to defects resulting from any action of the purchaser, including but not limited to mishandling, improper interfacing, operation outside of design limits, improper repair, or unauthorized modification. This WARRANTY is VOID if the unit shows evidence of having been tampered with or shows evidence of being damaged as a result of excessive corrosion; or current, heat, moisture or vibration; improper specification; misapplication; misuse or other operating conditions outside of OMEGA's control. Components which wear are not warranted, including but not limited to contact points, fuses, and triacs.

OMEGA is glad to offer suggestions on the use of our various products. Nevertheless, OMEGA only warrants that the parts manufactured by it will be as specified and free of defects.

OMEGA MAKES NO OTHER WARRANTIES OR REPRESENTATIONS OF ANY KIND WHATSOEVER, EXPRESSED OR IMPLIED, EXCEPT THAT OF TITLE, AND ALL IMPLIED WARRANTIES INCLUDING ANY WARRANTY OF MERCHANTABILITY AND FITNESS FOR A PARTICULAR PURPOSE ARE HEREBY DISCLAIMED.

LIMITATION OF LIABILITY: The remedies of purchaser set forth herein are exclusive and the total liability of OMEGA with respect to this order, whether based on contract, warranty, negligence, indemnification, strict liability or otherwise, shall not exceed the purchase price of the component upon which liability is based. In no event shall OMEGA be liable for consequential, incidental or special damages.

Every precaution for accuracy has been taken in the preparation of this manual; however, OMEGA ENGINEERING, INC. neither assumes responsibility for any omissions or errors that may appear nor assumes liability for any damages that result from the use of the products in accordance with the information in the manual.

SPECIAL CONDITIONS: Should this equipment be used in or with any nuclear installation or activity, purchaser will indemnify OMEGA and hold OMEGA harmless from any liability or damage whatsoever arising out of the use of the equipment in such a manner.

# Where Do I Find Everything I Need for Process Measurement and Control? OMEGA...Of Course!

## TEMPERATURE

- ☑ Thermocouple, RTD & Thermistor Probes, Connectors, Panels & Assemblies
- ☑ Wire: Thermocouple, RTD & Thermistor
- ☑ Calibrators & Ice Point References
- ☑ Recorders, Controllers & Process Monitors
- ☑ Infrared Pyrometers

## PRESSURE, STRAIN AND FORCE

- ☑ Transducers & Strain Gauges
- ☑ Load Cells & Pressure Gauges
- ☑ Displacement Transducers
- ☑ Instrumentation & Accessories

## FLOW/LEVEL

- ☑ Rotameters, Gas Mass Flowmeters & Flow Computers
- ☑ Air Velocity Indicators
- ☑ Turbine/Paddlewheel Systems
- ☑ Totalizers & Batch Controllers

## pH/CONDUCTIVITY

- ☑ pH Electrodes, Testers & Accessories
- ☑ Benchtop/Laboratory Meters
- ☑ Controllers, Calibrators, Simulators & Pumps
- ☑ Industrial pH & Conductivity Equipment

## DATA ACQUISITION

- ☑ Data Acquisition & Engineering Software
- ☑ Communications-Based Acquisition Systems
- ☑ Plug-in Cards for Apple, IBM & Compatibles
- ☑ Datalogging Systems
- ☑ Recorders, Printers & Plotters

## HEATERS

- ☑ Heating Cable
- ☑ Cartridge & Strip Heaters
- ☑ Immersion & Band Heaters
- ☑ Flexible Heaters
- ☑ Laboratory Heaters

## ENVIRONMENTAL MONITORING AND CONTROL

- ☑ Metering & Control Instrumentation
- ☑ Refractometers
- ☑ Pumps & Tubing
- ☑ Air, Soil & Water Monitors
- ☑ Industrial Water & Wastewater Treatment
- ☑ pH, Conductivity & Dissolved Oxygen Instruments

M1508/0798